

ORDENA ELS DIBUIXOS DE LA HISTÒRIA DE "LA RÍNXOLS D'OR" AMB 1, 2 I 3.

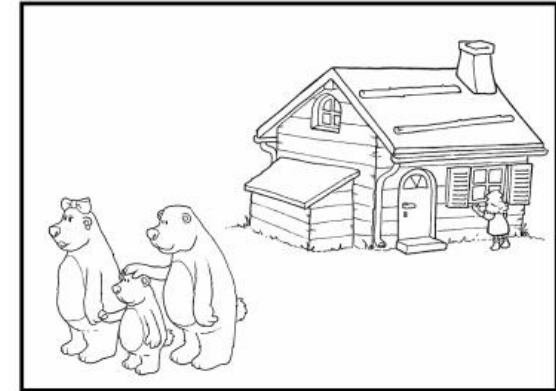

ORDENA ELS DIBUIXOS DE LA HISTÒRIA DE "LA RÍNXOLS D'OR" AMB 1, 2, 3, 4:

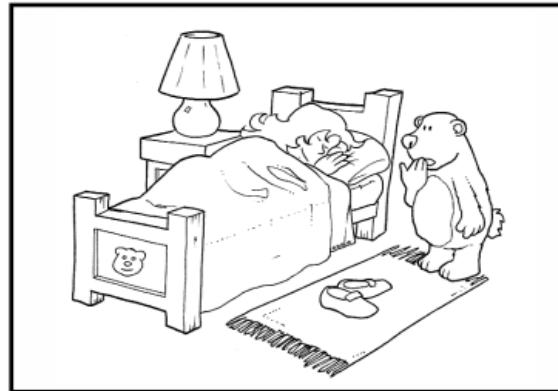
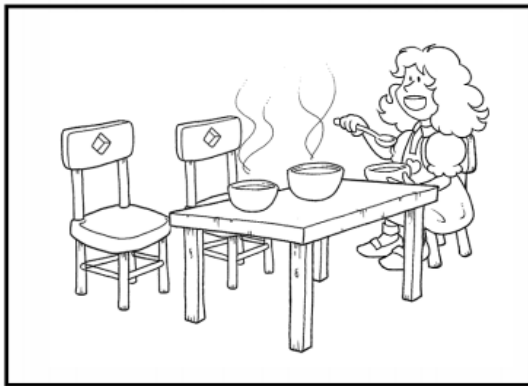
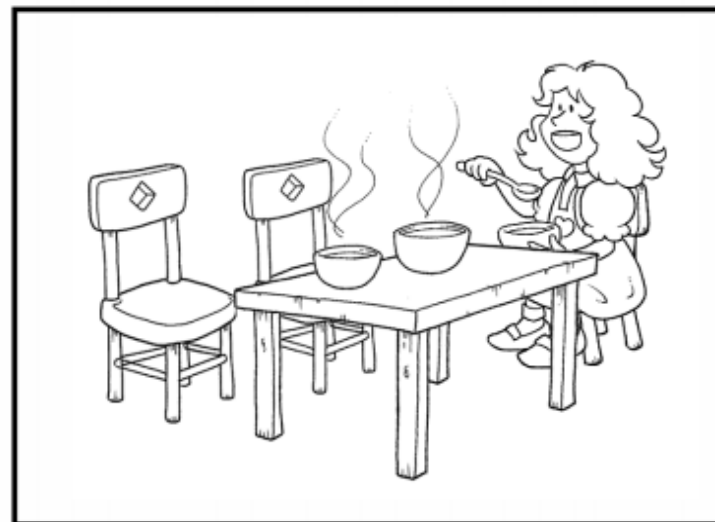
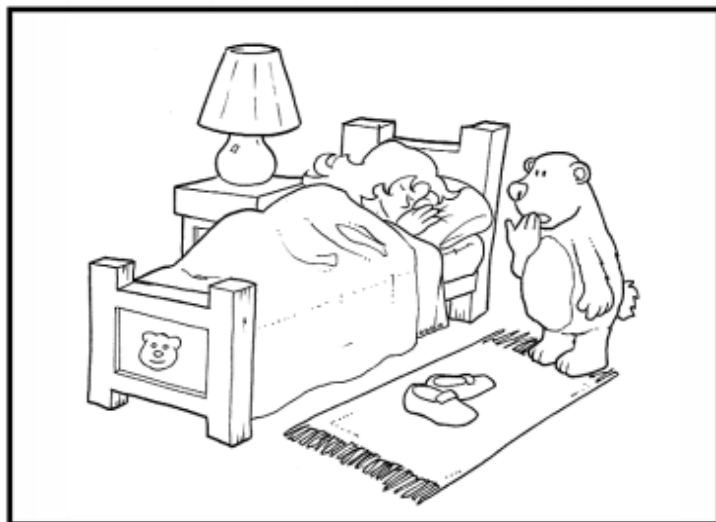
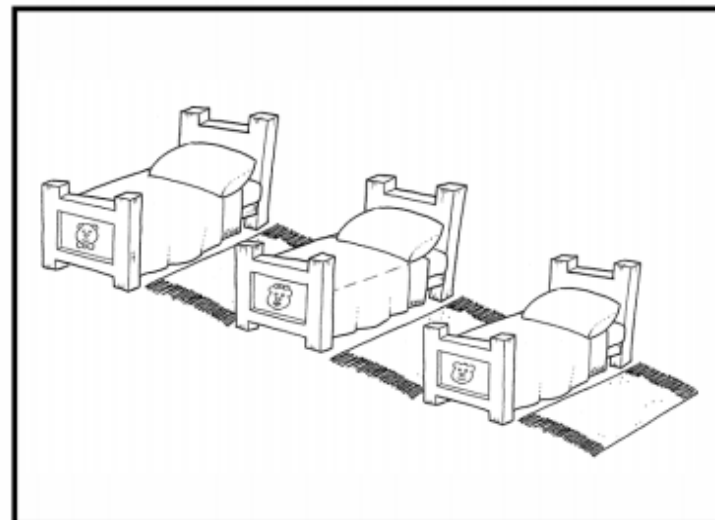
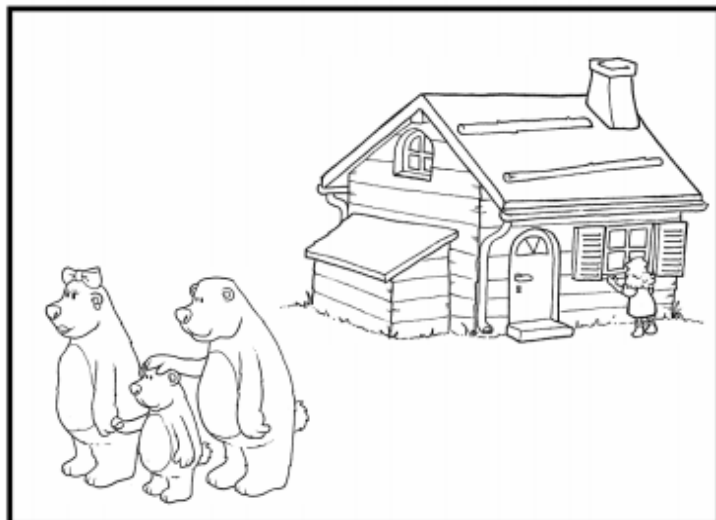

ORDENAELS DIBUIXOS DE LA HISTÒRIA DE "LA RÍN XOLS D'OR" AMB 1, 2, 3, 4 I 5.

